

Bedienblende / Control panel

Spannung / Voltage: **3 N AC 400V 50Hz**

Baugruppe / Group: **2** Ausgabe / Edition: **2.3.1**

Gültig ab Seriennummer / Applicable from serial. no.: **E61CA97061001**

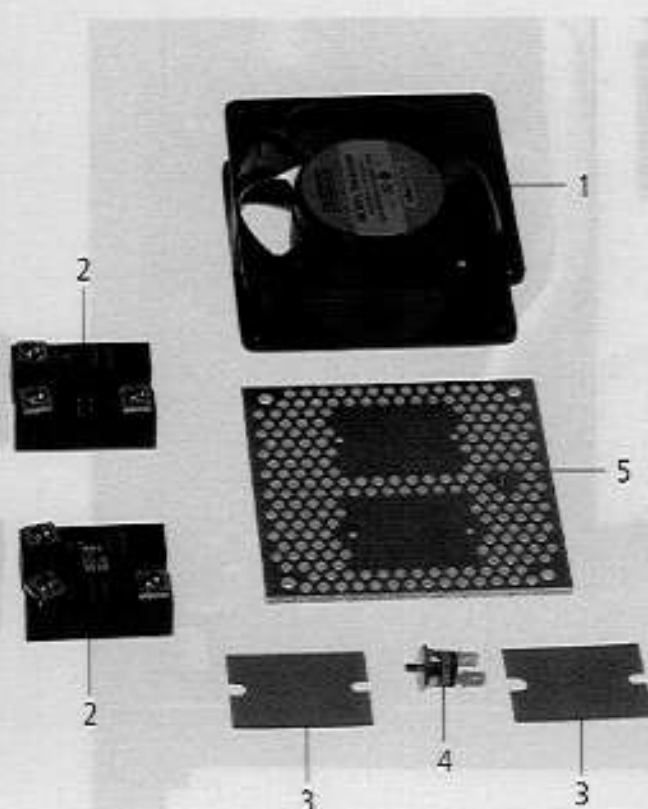
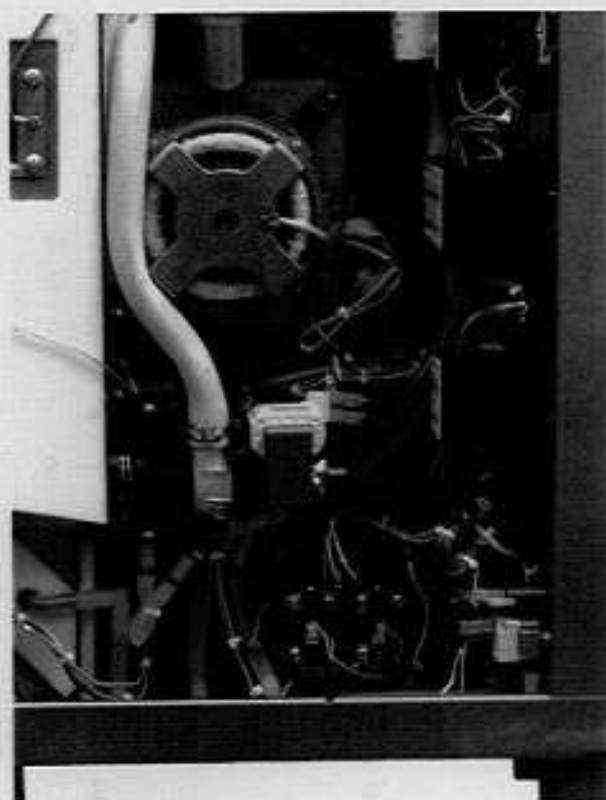

Pos.	St.	Ersatzteil Nr.	Bezeichnung	Description	Bez.
Pos.	Pcs.	Spare part no.			Sign.
1	1	3101.1008	Kühllüfter	Cooling motor	M2
2	2	3028.0533	Leistungshalbleiter 2x40A	Solid State relais 2pol, 40A	K3
-	4	1004.0500	Gewinde Schneidschraube M4x8 mit Linsenkopf	Raised countersunk metal screw M4x8	
-	4	1204.0120	Zahnscheibe A4,3	Toothed lock washer A4,3	
3	2	3028.0531	Wärmeleitfolie für Leistungshalbleiter	Heat transfer tape solid state relais	
4	1	3014.0325	Bimetallschalter 110°, Halbleiterplatte	Bimetal switch 110° solid state relay	F4
5	1	2930.1302	Kühlplatte-Leistungshalbleiter	Cooling plate solid state relay	
-	4	1004.0662	Innensechskantschraube M4x25	Allen screw M4x25	
-	4	1204.0120	Zahnscheibe A4,3	Toothed lock washer A4,3	
-	4	1306.0218	Unterlegscheibe A4,3 DIN9021	Washer A4,3 DIN9021	
-	4	1104.0122	Sechskant-Combimutter M4 verzinkt	Hex combination nut M4 galv	

Bedienblende / Control panel

 Spannung / Voltage: **3 N AC 400V 50Hz**

 Baugruppe / Group: **1** Ausgabe / Edition: **1.1.1**

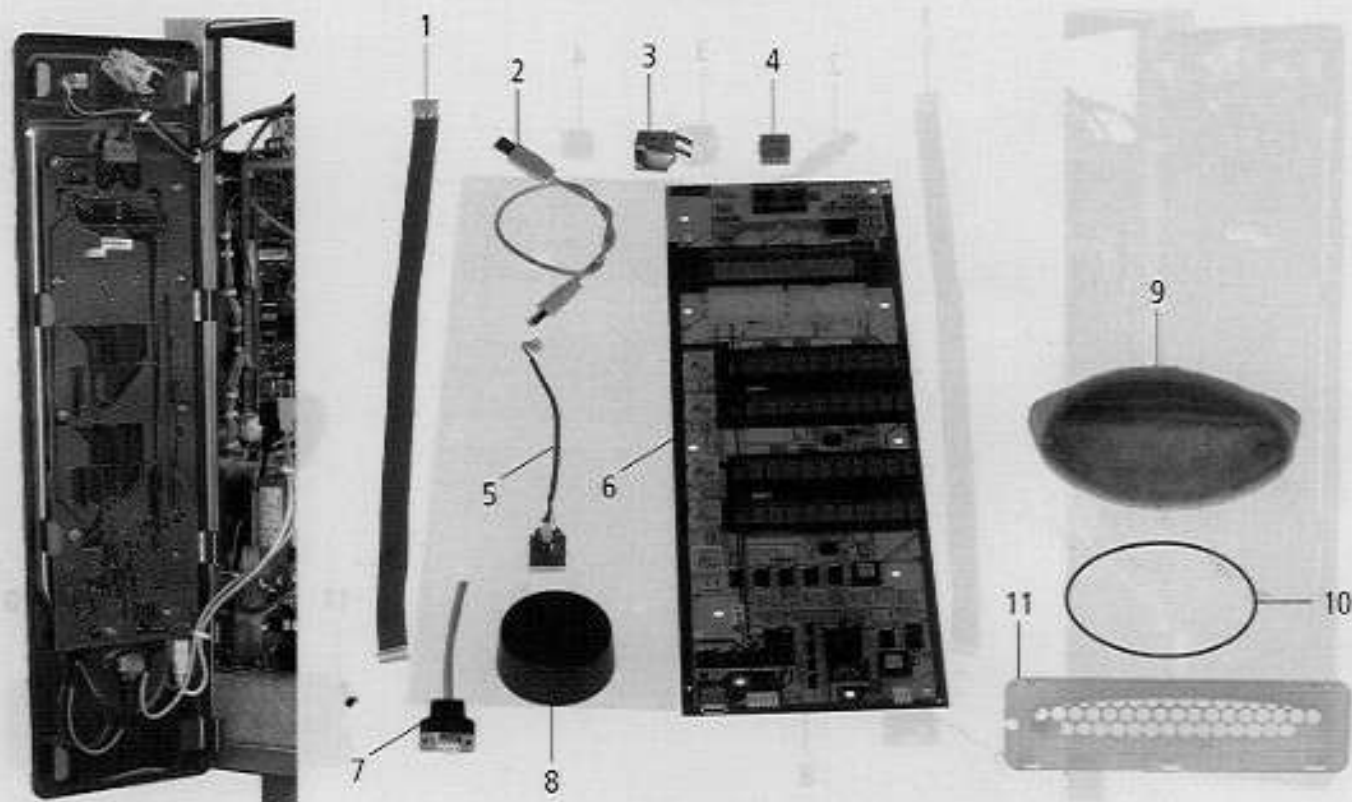
 Gültig ab Seriennummer / Applicable from serial. no.: **E61CA97061001**

Pos.	St.	Ersatzteil Nr.	Bezeichnung	Description	Bez. Sign.
Pos.	Pcs.	Spare part no.			
1	1	8720.1300	Datentransferkabel CPU-Bedienplatine	Bus cable CPU - operator pcb	
2	1	8720.1302	Kabel für Spannungsversorgung	Power supply cable operator pcb	
3	1	3006.0107	Alarmsummer 12V, AC	Buzzer 12V ac	T2
4	1	3040.0255	Steckerleiste 4pol, 5.08	Multipoint connector 4pol, 5.08	
5	1	8817.1303	Impulsgeber kpl.	Pulse generator cpl.	S6
6	1	3040.3020	Bedienplatine	Operator pcb	A1
7	1	8817.1040	Schnittstellenkabel	Interface cable	
8	1	3013.0355	Knebel für Impulsgeber	Dial for pulse generator	
9	1	5214.1300	Luftfilter Bedienblende	Air inlet filter control panel	
10	1	5012.0565	O-Ring d 115x2,5mm	O-ring d 115x2,5mm	
11	1	2039.0337	Filterträger Bedienblende	Filter support control panel	
-	1	5100.1011	Dichtung für Blendeneinsatz	Gasket frame for panel	

Gerätetür / Door

Spannung / Voltage: 3 N AC 400V 50Hz

Baugruppe / Group: 8 Ausgabe / Edition: 8.1.1

Gültig ab Seriennummer / Applicable from serial. no.: E61CA97061001

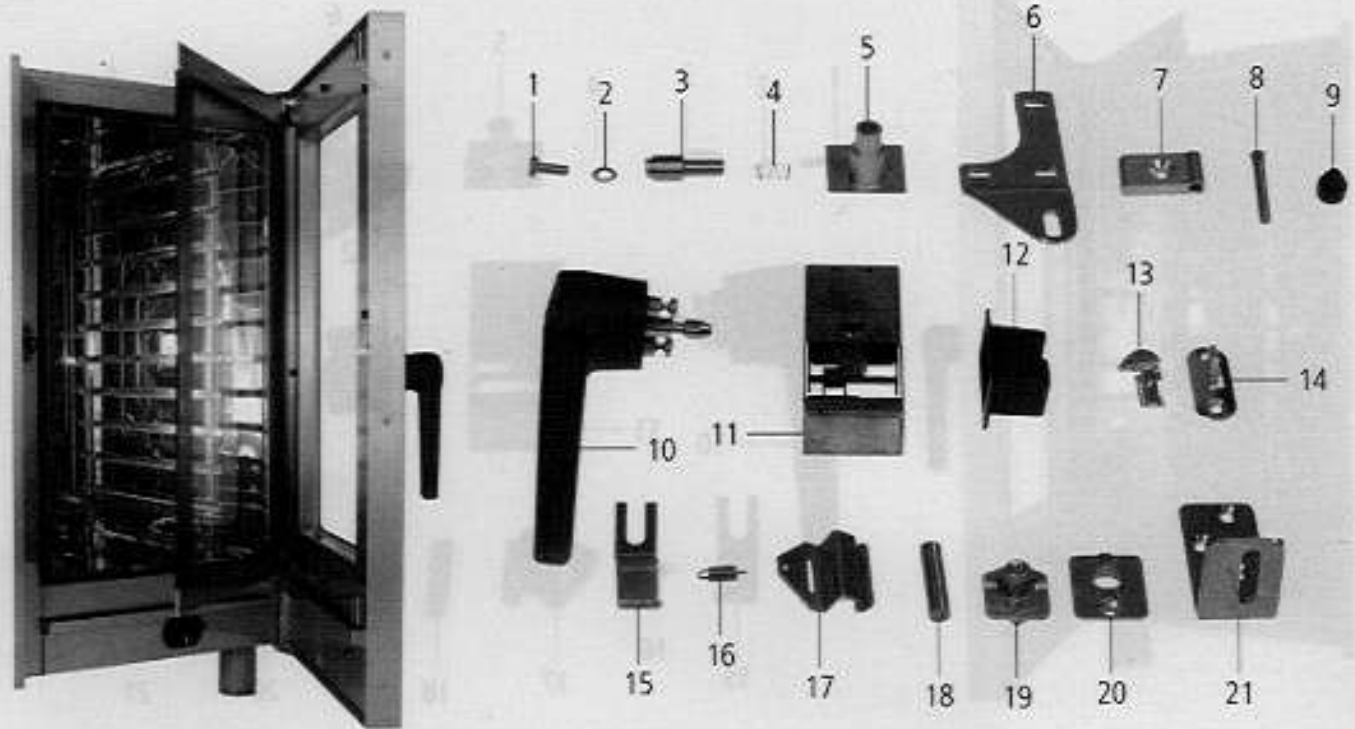

Pos.	St.	Ersatzteil Nr.	Bezeichnung	Description	Bez. Sign.
Pos.	Pcs.	Spare part no.			
-	1	8470.1300	Türe kpl.	Door cpl.	
-	1	8474.1336	Innenglasscheibe kpl.	Internal glass cpl.	
-	1	5105.1020	Garraumdichtung	Door gasket	
1	1	1006.0761	Sechskantschraube M 6x12	Hexagonal screw M 6x12	
2	1	1306.0120	Unterlegscheibe A6,4	Washer A6.4	
3	1	2120.1254	Achszapfen Tür oben	Door bolt top	
4	1	2001.0118	Druckfeder oberer Türhaltebolzen	Compression spring upper door bolt	
5	1	2940.1300	Achshülse Tür oben	Sleeve for door bolt top	
6	1	2939.1307	Türhaltewinkel oben	Door holding angle top	
-	3	1008.0200	Linsenkopfschraube mit Innensechskant	Raised countersunk allen screw M8x16	
7	1	2940.1309	Scharnier für Innenscheibe	Hinge for inner glass	
-	2	1005.1960	Senkschraube mit Innensechskant M5x16	Hex socket countersunk head screw M5x16	
8	1	2120.1258	Rändelbolzen für Türhaltescharnier	Knurled bolt for inner door hinge	
9	1	2039.0402	Puffer für Türe	Door buffer	
10	1	2016.1504	Türgriff	Door handle	
11	1	8474.1300	Verschluss kpl. für Tür	Lock for door handle cpl.	
12	1	2039.0319	Abdeckung f. Schloß Innenseite	Internal lock cover	
13	1	2940.1312	Kloben für Türe	Door catch	
-	1	1005.2000	Sperrzahnschraube M 5x8	Interlocking tooth screw M 5x8	
14	1	2940.1313	Klobenhalter für Türe	Base for door catch	
-	2	1006.0761	Sechskantschraube M 6x12	Hexagonal screw M 6x12	
15	1	2760.1396	Federhalter für Arretierung Innenglassscheibe	Spring support	
16	1	2002.0106	Zugfeder für Arretierung Innenglassscheibe	Tension spring for inner window	
17	1	2760.1395	Arretierung Innenglassscheibe	Holding bracket for interior glass	
18	1	3016.1409	Magnet rund Tischgeräte	Magnet round table models	
19	1	2940.1302	Rasthülse	Door setting bolt	
-	1	1008.0766	Sechskantschraube M8x30	Hexagonal screw M8x30	
20	1	2940.1303	Rastzapfen 110°	Stop bolt 110°	
-	1	1005.1960	Senkschraube mit Innensechskant M5x16	Hex socket countersunk head screw M5x16	
21	1	2930.1306	Türhaltewinkel unten	Door mounting support bottom	
-	3	1006.1960	Senkschraube mit Innensechskant M6x16	Hexagonal socket countersunk head screw M6x16	

Elektromontageplatte / Electrical Installation

 Spannung / Voltage: **3 N AC 400V 50Hz**

 Baugruppe / Group: **2** Ausgabe / Edition: **2.2.1**

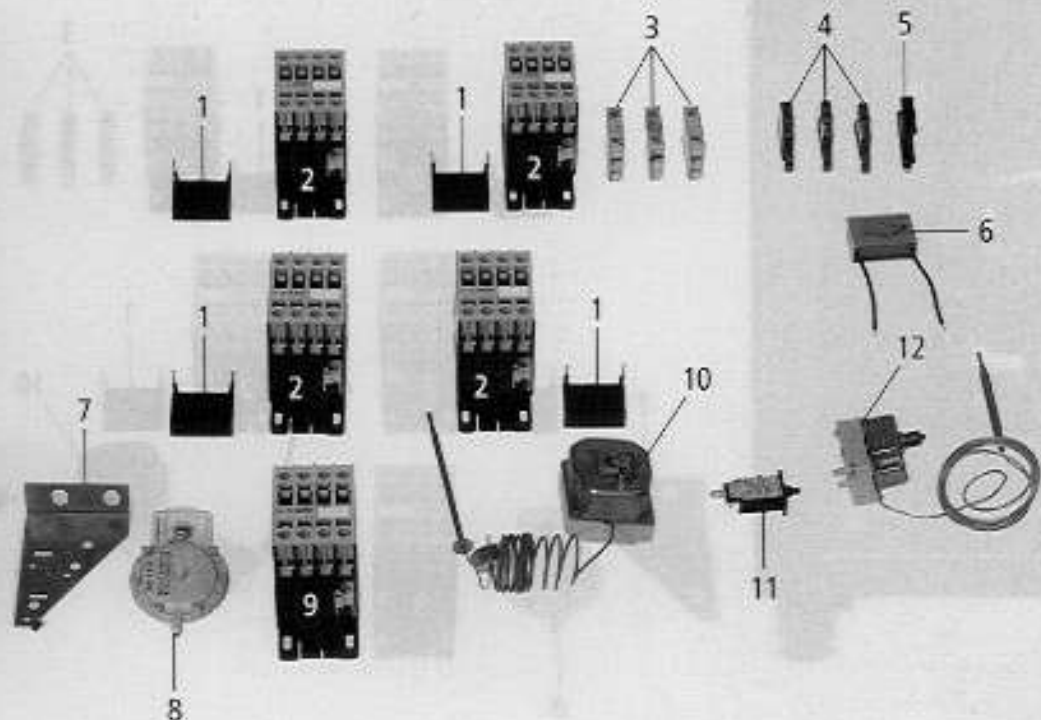
 Gültig ab Seriennummer / Applicable from serial. no.: **E61CA97061001**

Pos.	St.	Ersatzteil Nr.	Bezeichnung	Description	Bez.
Pos.	Pcs.	Spare part no.			Sign.
1	4	3028.0562	RC-Glied für LS4K - LS30K	RC-link for LS4K - LS30K	C2-C5
2	4	3028.0550	Schütz AEG LS 4K01	Contacteur AEG LS 4K01	K2
3	3	3028.0560	Hilfskontaktschalter HS07K10 N/C	Auxiliary contact switch HS07K10 N/C	
4	3	4001.1216	Reihen клемме 4mm ² grau	Terminal 4mm ² grey	
5	1	4001.1203	Endklammer für Tragschiene	End plate for supporting rail	
6	1	3102.1000	Wechselspannungskondensator 1,5 µF,250V	Capacitor 1,5 µF,250V AC	C1
7	1	2760.1120	Halte winkel für Drucksensor	Holding bracket for pressure sensor	
8	1	3017.1002	Drucksensor für Feuchtigkeitsmessung	Pressure sensor for humidity control	P1
9	1	3028.0551	Schütz AEG LS 4K10	Contacteur AEG LS 4K10	K1
10	1	3014.0326	Sicherheitstemperaturbegrenzer 360°C	Safety temperature limiter 360°C	F3
11	1	3014.0402	Überstromauslöser einpolig f. Motorschutz	Current limiter for motor protection	F5
12	1	3014.0300	Trockengeherschutz 135°C	Dry up protector 135°C	F2

Elektromontageplatte / Electrical Installation

Spannung / Voltage: **3 N AC 400V 50Hz**

Baugruppe / Group: **2** Ausgabe / Edition: **2.3.1**

Gültig ab Seriennummer / Applicable from serial. no.: **E22CA97061001**

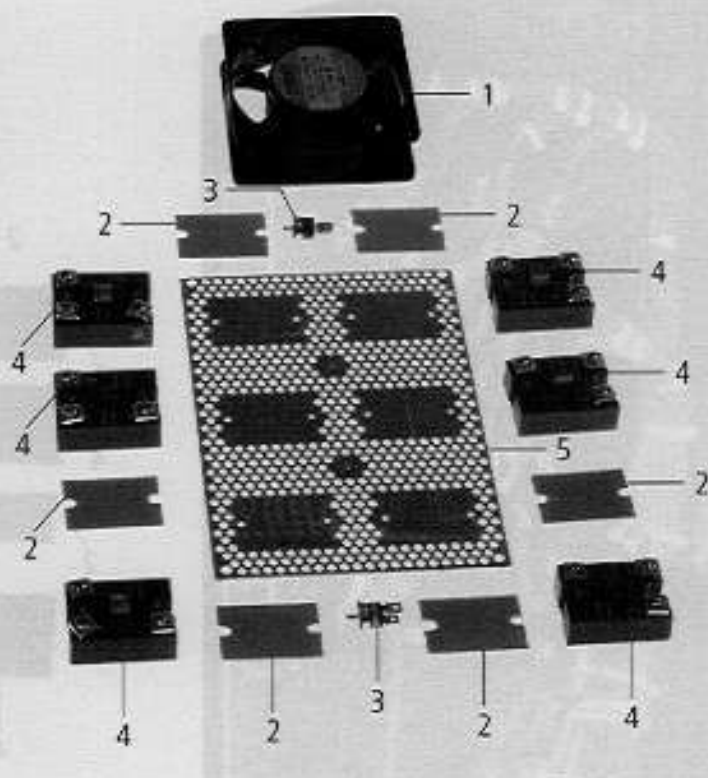
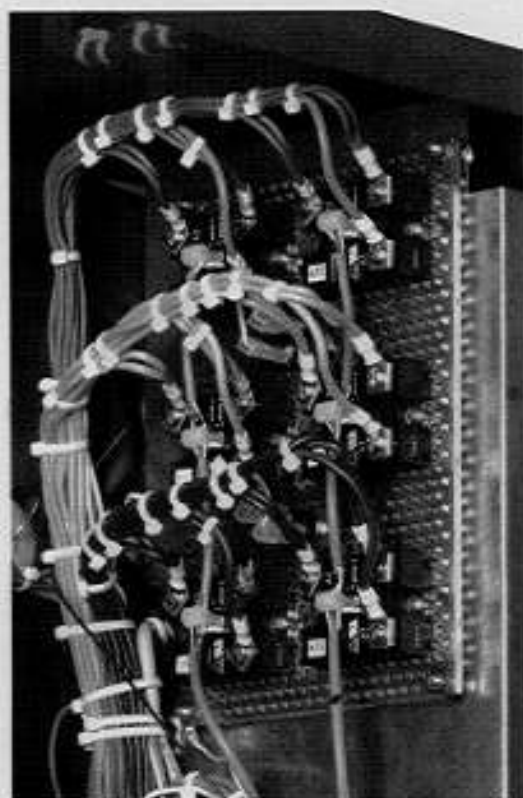

Pos.	St.	Ersatzteil Nr.	Bezeichnung	Description	Bez.
Pos.	Pcs.	Spare part no.			Sign.
1	1	3101.1008	Kühllüfter	Cooling motor	M2
2	6	3028.0531	Wärmeleitfolie für Leistungshalbleiter	Heat transfer tape solid state relais	
3	2	3014.0325	Bimetallschalter 110°, Halbleiterplatte	Bimetal switch 110° solid state relay	F4
4	6	3028.0533	Leistungshalbleiter 2x40A	Solid State relais 2pol, 40A	K3
-	12	1004.0500	Gewinde Schneidschraube M4x8 mit Linsenkopf	Raised countersunk metal screw M4x8	
-	12	1204.0120	Zahnscheibe A4,3	Toothed lock washer A4,3	
5	12	2930.1304	Kühlplatte-Leistungshalbleiter	Cooling plate solid state relay	
-	4	1004.0662	Innensechskantschraube M4x25	Allen screw M4x25	
-	4	1204.0120	Zahnscheibe A4,3	Toothed lock washer A4,3	
-	4	1306.0218	Unterlegscheibe A4,3 DIN9021	Washer A4,3 DIN9021	
-	4	1104.0122	Sechskant-Combimutter M4 verzinkt	Hex combination nut M4 galv	

Elektromontageplatte / Electrical Installation

 Spannung / Voltage: **3 N AC 400V 50Hz**

 Baugruppe / Group: **2** Ausgabe / Edition: **2.1.1**

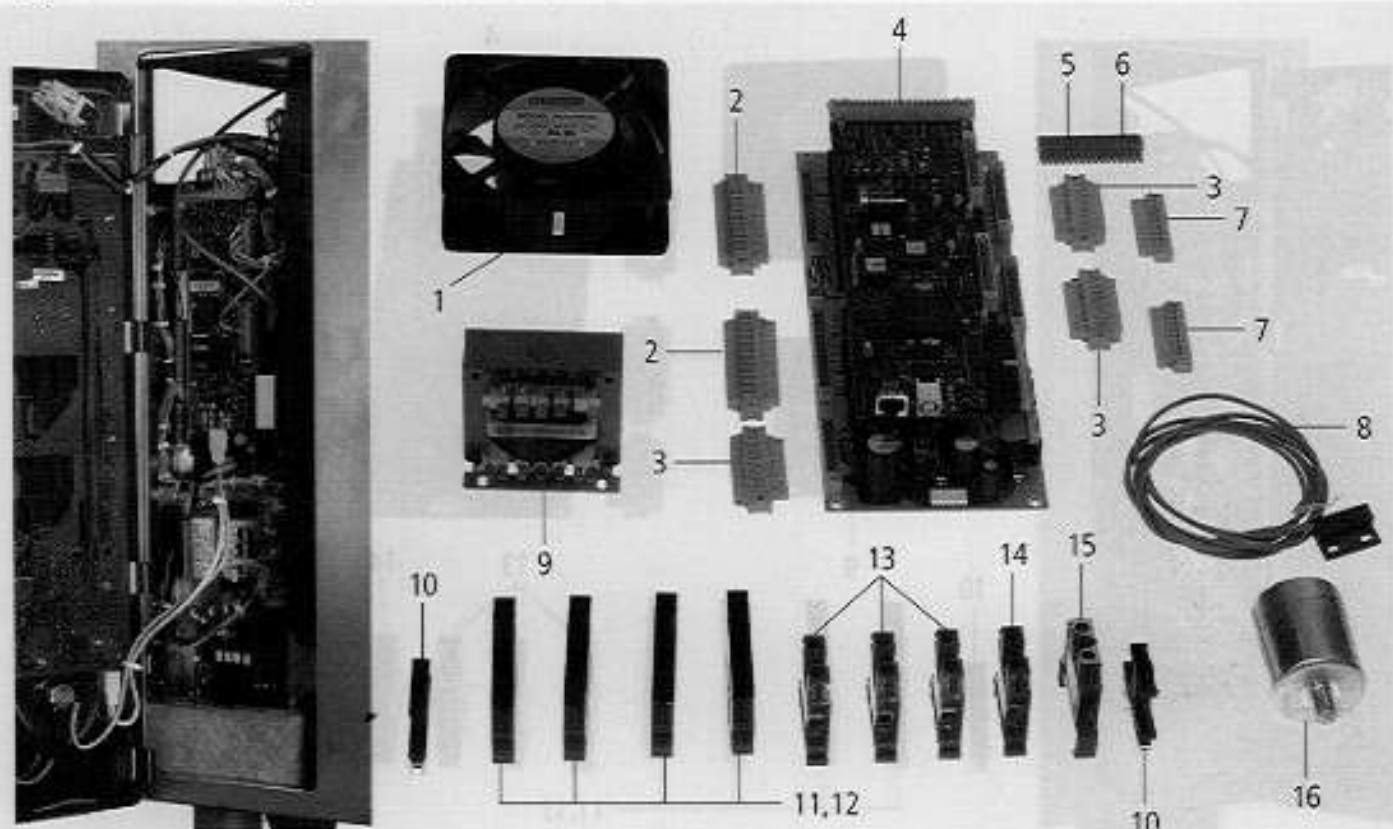
 Gültig ab Seriennummer / Applicable from serial. no.: **E61CA97061001**

Pos.	St.	Ersatzteil Nr.	Bezeichnung	Description	Bez.
Pos.	Pcs.	Spare part no.			Sign.
1	1	3101.1008	Kühllüfter	Cooling motor	M2
2	2	3040.0254	Steckerleiste 12pol, 5.08	Multipoint connector 12pol, 5.08	
3	3	3040.0253	Steckerleiste 8polig, 5.08Raster	Multipoint connector 8pol, 5.08	
4	1	3040.3000	Bedienplatine	Operator pcb	A1
5	1	3040.0262	Steckerleiste links 10polig, 3.5	Multipoint connector left 10polig, 3.5	
6	1	3040.0261	Steckerleiste rechts 10polig 3.5	Multipoint connector right 10polig	
7	2	3040.0256	Steckerleiste 12pol, 3.5	Multipoint connector 12pol, 3.5	
8	1	3016.1415	Türkontaktschalter	Door contact switch	S3
9	1	3037.0240	Steuertrafo 200-260V	Control transformer 200-260V	T1
10	2	4001.1203	Endklammer für Tragschiene	End plate for supporting rail	
11	4	4001.1283	Sicherungsklemme 6x32 4 qmm	Fuse holder terminal block 4qmm,6x32mm	F1,F7
12	4	4001.0224	Sicherung 6.35x32mm, 6.3A träge	Fuse 6.35x32mm, 6.3A slow	F1,F7
13	3	4001.1202	Reihenklammer 16mm² grau	Terminal 16mm² grey	
14	1	4001.1250	Reihenklammer 16mm² blau	Terminal 16mm² blue	
15	1	4001.1210	Erdungsreihenklammer 16mm² gelb/grün	Earth terminal 16mm² yellow/green	
16	1	3001.0455	Entstörfilter	Electronic noise filter	Z1

Handbrause / Hand shower

Spannung / Voltage: **3 N AC 400V 50Hz**

Baugruppe / Group: **10** Ausgabe / Edition: **10.1.1**

Gültig ab Seriennummer / Applicable from serial. no.: **E61CA97061001**

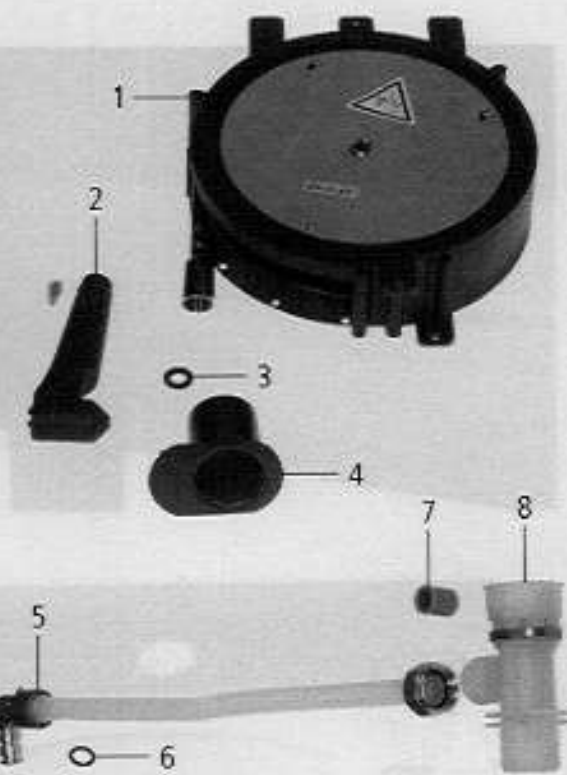

Pos.	St.	Ersatzteil Nr.	Bezeichnung	Description	Bez. Sign.
Pos.	Pcs.	Spare part no.			
1	1	8655.2021	Schlauchroller	Handshower roll guide	
2	1	2060.1000	Handbrause	Hand shower	
3	1	5012.0539	Dichtung für Verschraubung G 1/2"	Gasket for G1/2" threaded joint	
4	1	2060.1210	Tulpe für Handbrause	Tulip for handshower	
-	4	1107.0103	Schnellbefestiger d3mm	Quick fastener d3mm	
5	1	2062.0327	Anschlußrohr Schlauchroller	Connecting pipe hand shower	
6	2	2060.0228	O-Ring für Brauseschlauch	O-ring for shower hose	
7	1	2069.0105	Rückschlagventil DN8	Non return valve DN8	
8	1	8464.1300	T-Stück Wasseranschluss Handbrause	T-water connection handshower	
9	1	8455.1315	Gerätetropfwanne	Drip collector	
10	2	2066.0525	Schlauchklemme 22,1mm	Hose clamp 22,1mm	
11	1	2110.1002	Silikonschlauch d15x3	Silicone hose d15x3	

Heißluftheizung / Hot air heating

Spannung / Voltage: **3 N AC 400V 50Hz**

Baugruppe / Group: **5** Ausgabe / Edition: **5.1.1**

Gültig ab Seriennummer / Applicable from serial. no.: **E61CA97061001**

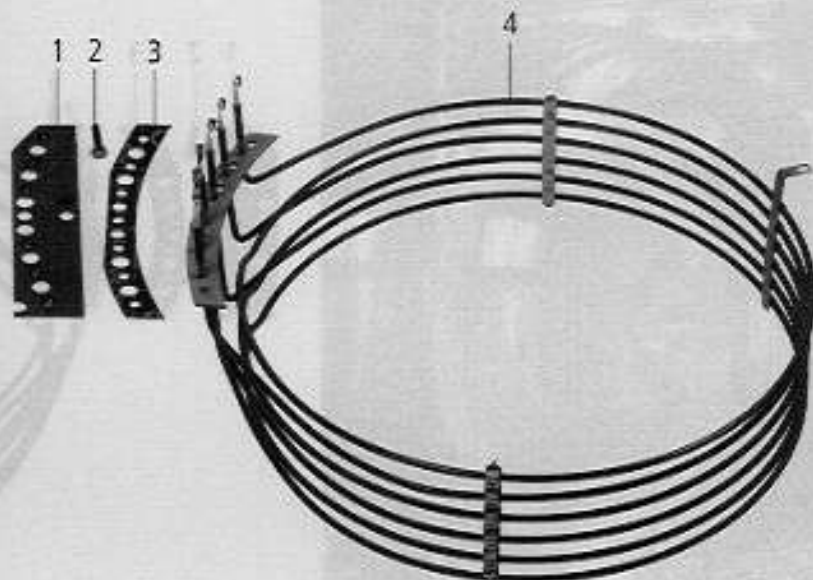
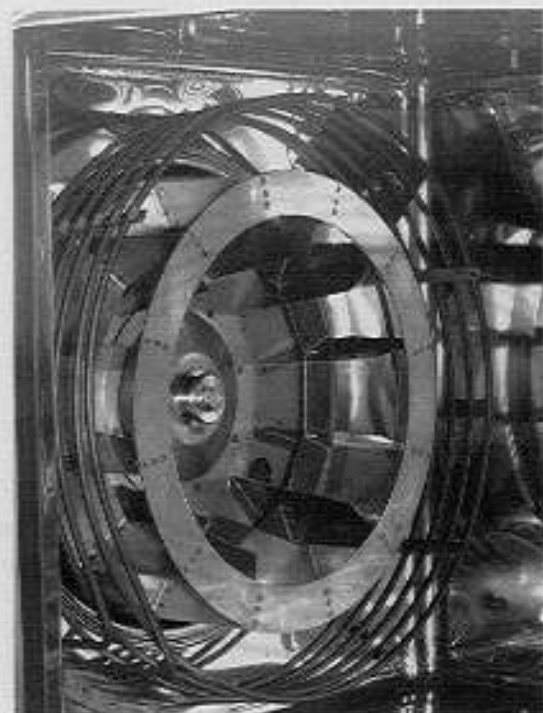

Pos.	St.	Ersatzteil Nr.	Bezeichnung	Description	Bez.
Pos.	Pcs.	Spare part no.			Sign.
1	1	2150.1250	Flansch Aussenseite	External flange for hot air heater	
2	6	1006.0766	Sechskantschraube M 6x25, HL Register	Hex screw M6x25, hot air heater	
3	1	5110.1009	Dichtring f. Heizregister	Seal ring for heating assembly	
4	1	3200.1000	Heizregister innen 230V	Inner heating assembly 230V	
-	1	1306.0222	Unterlegscheibe A6,4	Washer A6.4	
-	1	1106.0360	Hutmutter M6 hohe Form	Cap nut M6, high shape	

Garraum / Interior cabinet

Spannung / Voltage: **3 N AC 400V 50Hz**

Baugruppe / Group: **7** Ausgabe / Edition: **7.1.1**

Gültig ab Seriennummer / Applicable from serial. no.: **E61CA97061001**

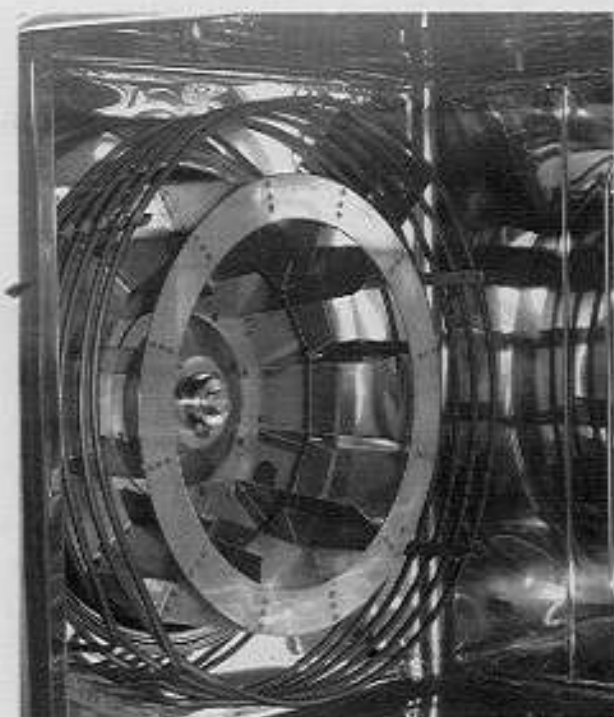

Pos.	St.	Ersatzteil Nr.	Bezeichnung	Description	Bez. Sign.
Pos.	Pcs.	Spare part no.			
-	1	8516.1301	Luftleitblech	Air baffle	
1	1	3014.0162	Dichtkegel für Thermoelement	Sealing cone for thermo element	
2	1	3014.0163	Stopfbuchsnippel für Thermoelement	Gasket sleeve with nipple	
3	1	3014.1000	Thermoelement - lang -	Thermocouple -long-	B1
4	1	3035.0710	Einstechfühler	Meat probe sensor	B3
5	1	1112.0110	Sechskantmutter M 10	Hexagonal nut M10	
6	1	1315.0105	Kupferdichtring für Einstechfühler	Copper washer for meat probe sensor	
7	1	3014.0326	Sicherheitstemperaturbegrenzer 360°C	Safety temperature limiter 360°C	F3
8	1	2005.0302	Ablaufsieb	Outlet sieve	
9	4	1008.0753	Sechskantschraube M 5x8	Hexagonal screw M5x8	
10	1	8514.1017	Andrückrahmen f. Garraumbeleuchtung	Press down frame for interior lighting	
11	1	5110.1022	Dichtungsrahmen außen	External gasket frame	
12	1	5201.1000	Glas f. Garraumbeleuchtung	Glass for interior lamp	
13	1	5110.1023	Dichtungsrahmen innen	Internal gasket frame	
14	1	3024.0201	Halogengarraumlampe 10 W/12V/300°	Halogen bulb 10 W/12V/300°	
15	1	8514.1018	Reflektor kpl. f. Garraumbeleuchtung	Reflector unit for interior lighting	

Sonstiges / Miscellaneous

Baugruppe / Group: 12 Ausgabe / Edition: 12.1.1

Gültig ab Seriennummer / Applicable from serial. no.: E61CA97061001

Pos.	Ersatzteilnr.:	Bezeichnung	Description
Pos.	Spare part no.		
1	1003.2260	Linsensenk-Blechschaube HC4,2x16	Raised countersunk head - self-tapping screw HC4,2x16
2	1004.2160	Sechskant Blechschaube B4,2x16	Hex head tapping screw B4, 2x16
3	1104.0821	Blechmutter B3,9	Climp B3,9
4	1107.0100	Schnellbefestiger d4,0 mm	Quick fastener d4.0 mm
5	1107.0101	Schnellbefestiger d5,0mm	Quick fastener d5,0mm
6	1107.0102	Schnellbefestiger d12mm	Quick fastener d12mm
7	1107.0103	Schnellbefestiger d3mm	Quick fastener d3mm
8	1311.2260	Schraubenrosette 5x12,5	Rosette 5x12,5
9	1603.0165	Blindniete 3,2x9,5	Blind rivet 3.2x9.5
10	1901.0042	Blechklammer für Außenmantel	Clamp for exterior cabinet
11	1901.0044	Blechklammer für Deckel bis 05/95	Clamp for cover up to 05/95
12	2001.0042	Loctite Schraubensicherung 10ml	Screw locking, heat resistant 10ml
13	2005.0603	Lenkrolle d/125 mit Feststeller	Castor d/125 with stopper
14	2005.0604	Lenkrolle d/125 ohne Feststeller	Castor d/125 without stopper
15	2039.0111	Metall-Einsteckfuß 40x40	Foot adjustable metal, 40 x 40
16	2039.0120	Fußoberteil 85mm	Upper part of pedestal 85mm
17	2039.0121	Fußunterteil	Lower part of pedestal
18	3016.1409	Magnet rund Tischgeräte	Magnet round table models
19	4002.0100	Flachsteckhülse 2,5x6,3	Cable shoes 2,5x6,3
20	4004.0100	Aderendhülse 1,0mm ²	Wire end sleeve 1,0mm ²
21	4004.0101	Aderendhülse 1,5mm ²	Wire end sleeve 1,5mm ²
22	4004.0102	Aderendhülse 2,5mm ²	Wire end sleeve 2,5mm ²
23	4004.0103	Aderendhülse 4mm ²	Wire end sleeve 4mm ²
24	4004.0104	Aderendhülse 6mm ²	Wire end sleeve 6mm ²
25	4004.0105	Aderendhülse 10mm ²	Wire end sleeve 10mm ²
26	4004.0106	Aderendhülse 16mm ²	Wire end sleeve 16mm ²
27	4004.0114	Aderendhülse 0,75mm ²	Wire end sleeve 0,75mm ²
28	4005.0101	Kabelbinder 145mm lang	Cable strap 145mm long
29	4005.0102	Kabelbinder 100mm lang	Cable strap 100mm long
30	4007.0305	Kabelverschraubung PG 21	Screw-type conduit fitting PG 21
31	4007.0306	Reduzierstück PG 29/21	Reducing socket PG 29/21
32	4007.0405	Kabelverschraubung PG 16	Screw-type conduit fitting PG 16
33	4007.0406	Reduzierstück PG 29/16	Reducing socket PG 29/16
34	4007.0521	Sechskantmutter für PG 13,5	Hex screw for PG 13,5
35	4007.0526	Sechskantmutter für PG 21	Hex screw for PG 21
36	4007.0604	Kabelverschraubung PG 42 mit Zugentlast.	Cable connection PG 42, strain relief
37	4007.0605	Sechskantmutter PG42	Lock nut cable connection PG 42
38	4007.0606	Kabelverschraubung PG 36	Screw-type conduit fitting PG 36
39	4007.0607	Sechskantmutter für PG 36	Hex screw for PG 36
40	4007.0614	Stopfen PG 13,5	Plug PG 13,5
41	4007.0615	Stopfen PG 21	Plug PG 21
42	4007.0621	Durchführungsstülpe d 36mm	Lead-in grommet d 36 mm
43	5003.0300	Isolierung Dampfgenerator 1250x1250mm	Insulation steam generator 1250x1250mm
44	5006.0200	Tube Silikon E41	Silicone (tube) E41
45	5006.0500	Kleber Isolierung Dampfgenerator 310ml	Adhesive isulation steam generator 310ml
46	6004.0100	Handdruck Sprühpistole	Spray-pistol
47	6004.0101	Verlängerung Handdruck Sprühpistole	Lengthening piece for spray-pistol
48	6004.0102	Dichtung Handdruck Sprühpistole	Gasket for spray-pistol
49	6004.0203	Entkalker-Fußpumpe	Descaler foot pump
50	6006.0101	RATIONAL Spezialreiniger	RATIONAL special cleaning agent
51	6006.0110	RATIONAL Entkalker	RATIONAL descaler
52	9003.0202	Unimoly plus, 180 °C	Unimoly plus, 180 °C
53	9006.0850	Metallwaschcreme	Stainless steel cleaning paste

Motor und Lüfterrad / Motor and fan wheel

 Spannung / Voltage: **3 N AC 400V 50Hz**

 Baugruppe / Group: **6** Ausgabe / Edition: **6.1.1**

 Gültig ab Seriennummer / Applicable from serial. no.: **E61CA97061001**

Motor / Voltage: 3 N AC 400V 50Hz

Validité à compter numéro de série / Valid from serial number: E61CA97061001

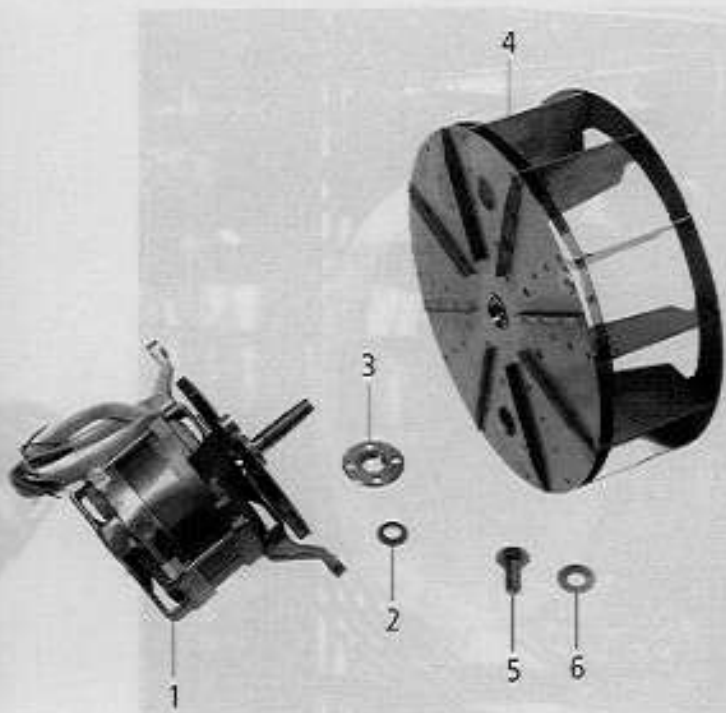
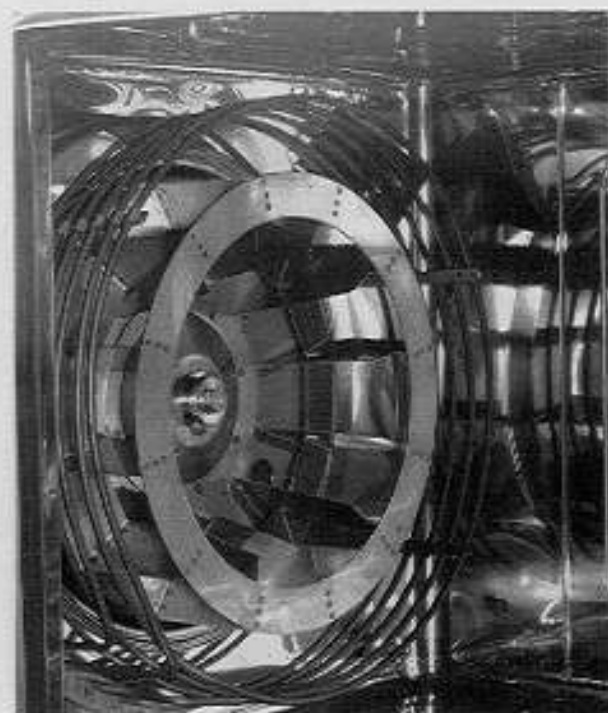

Pos.	St.	Ersatzteil Nr.	Bezeichnung	Description	Bez. Sign.
Pos.	Pcs.	Spare part no.			
1	1	3100.1020	Lüftermotor 4/8pol	Fan motor 4/4pol	M1
-	4	1108.0260	Sechskantmutter M 8	Hexagonal nut M8	
-	4	1208.0260	Federring B8	Spring washer B8	
2	1	5001.0207	Motorwellendichtung	Motor shaft gasket type	
3	1	2016.0876	Dichtungsflansch für Motorwelle	Gasket flange for engine shaft	
-	4	1106.0220	Sechskantmutter M6 flach	Hexagonal nut M6 flat	
-	4	1306.0120	Unterlegscheibe A6,4	Washer A6.4	
4	1	2012.0507	Lüfterrad	Fan wheel	
5	1	1010.0762	Sechskantschraube M 10x20	Hexagonal screw M10x20	
6	1	1328.0102	Sperrkantscheibe A10,2	Safety washer A10,2	

Dampfgenerator / Steam generator

Spannung / Voltage: **3 N AC 400V 50Hz**

Baugruppe / Group: **4** Ausgabe / Edition: **4.1.1**

Gültig ab Seriennummer / Applicable from serial. no.: **E61CA97061001**

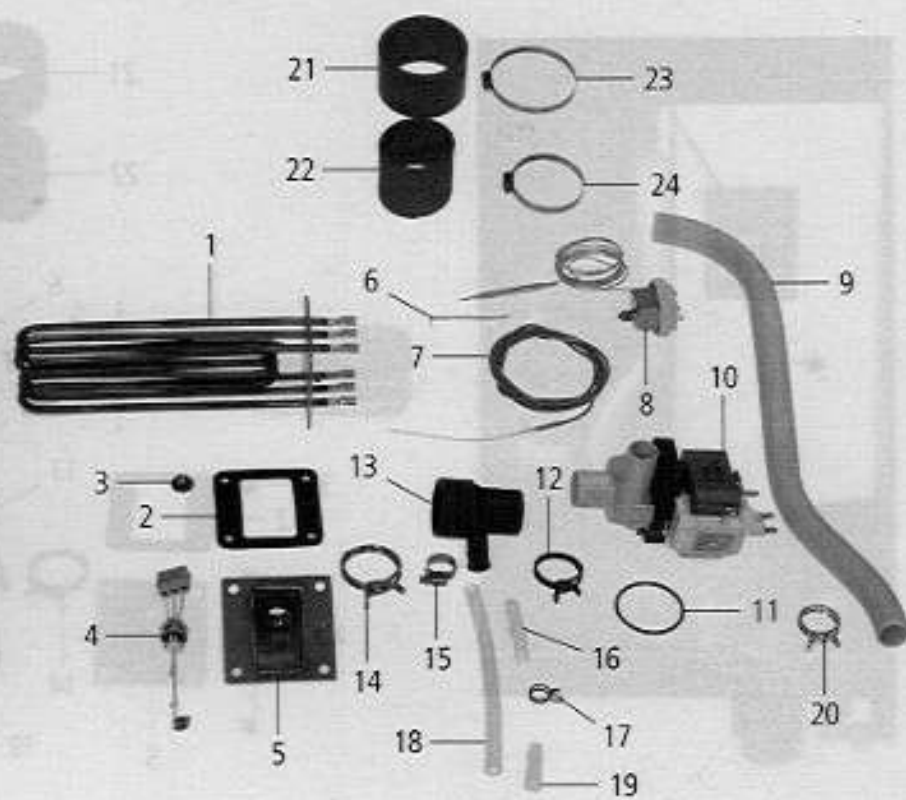
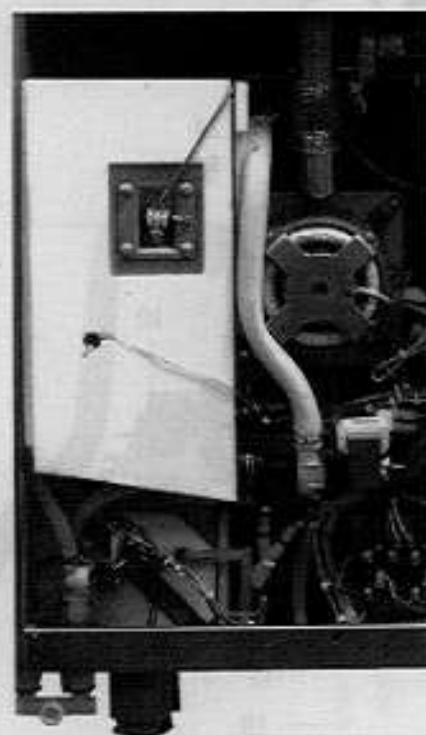

Pos.	St.	Ersatzteil Nr.	Bezeichnung	Description	Bez. Sign.
Pos.	Pcs.	Spare part no.			
-	-	2067.0050	Silikonschlauch 1m	Silicone hose 1m	
1	1	3201.1000	Tauchheizkörper 3x3 kw 230V	Heating element 3x3 kw 230V	
2	2	5110.1003	Dichtung f. Tauchheizkörper	Gasket for heating element	
3	8	1106.0803	Sechskant-Combimutter M6 verzinkt	Hex combi nut M6 galv	
4	1	3002.0401	Füllstandselektrode 70mm	Filling level electrode 70mm	S2
5	1	2920.1300	Einsatz Niveauelektrode	Level elektrode insert	
6	1	2740.1040	Klemmblech Dampfgenerator	Clamping plate for steam generator	
7	1	3014.0165	Thermoelement Dampfgenerator	Thermo element steam generator	B5
8	1	3014.0300	Trockengehschutz 135°C	Dry up protector 135°C	F2
9	1	2112.1302	Entleerschlauch	Emptying hose type 61	
10	1	3002.1000	Entleerungspumpe 200-240V 50/60Hz	Emptying pump 200-240V 50/60Hz	M4
11	1	5012.0560	O-Ring Dichtung Entleerungspumpe	O-Ring gasket emptying pump	
12	1	2066.0519	Schlauchklemme 35,6mm	Hose clamp 35,6mm	
13	1	2118.1000	Pumpenanschlußstutzen	Pump connection spout	
14	1	2066.0526	Schlauchklemme 46mm	Hose clamp 46mm	
15	1	2066.0530	Schlauchklemme 16,4mm	Hose clamp 16,4mm	
16	1	2062.0331	Verbindungsteil GS 10	Connecting piece GS 10	
17	1	2066.0527	Schlauchklemme 14mm	Hose clamp 14mm	
18	1	2110.1008	Silikonschlauch DG-Entleerung	Drain hose steam generator	
19	1	2120.1259	Stopfen 10mm Entleerschlauch DG	Stop plug 10mm drain hose steam generat.	
20	2	2066.0518	Schlauchklemme 30mm	Hose clamp 30mm	
21	1	2112.1306	Dampfschlauch	Steam hose	
22	1	2112.1006	Dampfschlauch 50x7mm	Steam hose 50x7mm	
23	2	2066.0504	Schlauchselle 40-60mm	Hose clamp 40-60mm	
24	2	2066.0300	Schlauchselle 50-70mm	Hose clamp 50-70mm	

Wasseranschluß, Ablöschung / Water supply, Quenching box

Spannung / Voltage: **3 N AC 400V 50Hz**

Baugruppe / Group: **9** Ausgabe / Edition: **9.1.1**

Gültig ab Seriennummer / Applicable from serial. no.: **E61CA97061001**

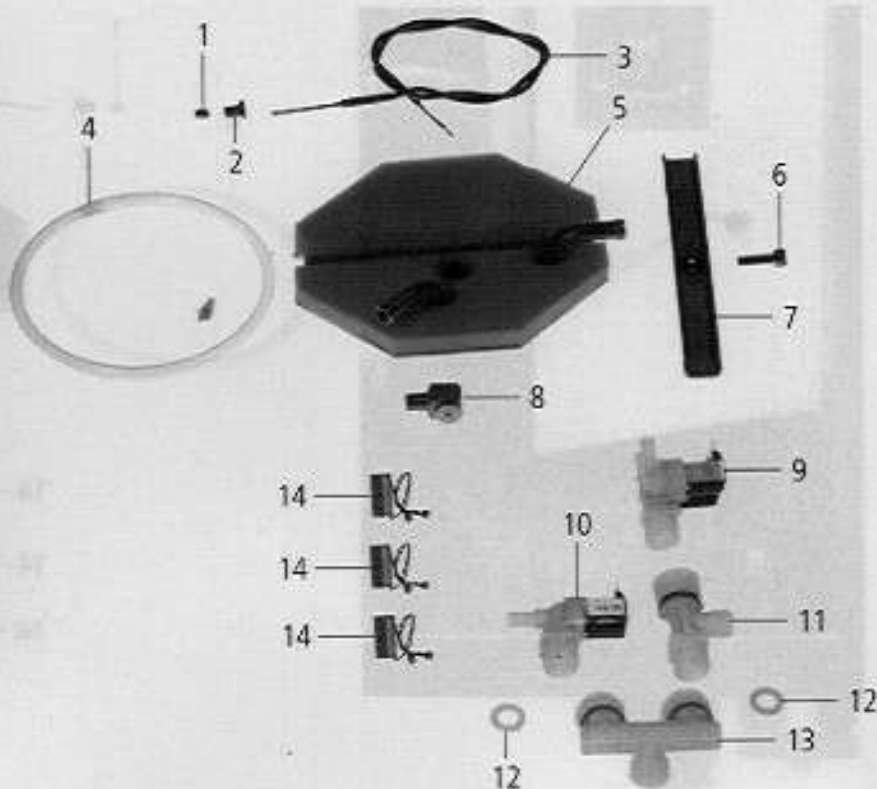
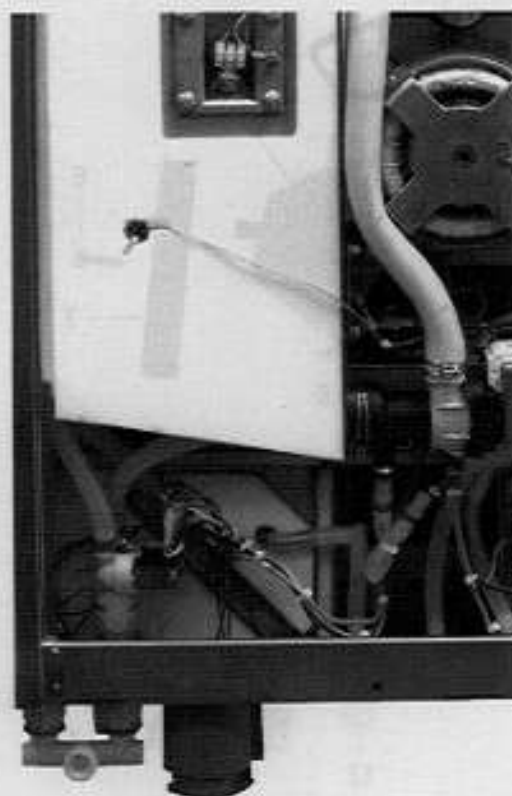

Pos.	St.	Ersatzteil Nr.	Bezeichnung	Description	Bez. Sign.
Pos.	Pcs.	Spare part no.			
-	-	2067.0050	Silikonschlauch 1m	Silicone hose 1m	
-	6	2066.0205	Schlauchschnelle 12-18mm	Hose clamp 12-18mm	
1	1	3014.0162	Dichtkegel für Thermoelement	Sealing cone for thermo element	
2	1	3014.0163	Stopfbuchsnippel für Thermoelement	Gasket sleeve with nipple	
3	1	3014.1005	Thermoelement kurz	Thermocouple short	B2
4	1	5012.0566	O-Ring Dichtung Ablöschkasten	O-Ring gasket quenching chamber	
5	1	8666.1318	Flansch Ablöschkasten	Flange quenching chamber	
6	1	1008.0752	Sechskantschraube M5x10	Hexagonal screw M5x10	
7	1	2715.1320	Spannbügel für Revisionsdeckel Ablöschkasten	Cross bar for cover quenching box	
8	1	2016.0935	Ablöschdüse 2,3 l/min	Quenching nozzle 2.3 l/min.	
9	1	3002.0330	Doppelmagnetventil kpl. 220-240V 50Hz	Double solenoid valve unit 220-240V 50Hz	Y1,Y3
10	1	3002.0331	Einfachmagnetventil kpl. 220-240V 50Hz	Single solenoid valve unit 220-240V 50Hz	Y2
11	1	8464.1300	T-Stück Wasseranschluss Handbrause	T-water connection handshower	
12	3	5110.1024	Dichtung für Verschraubung G 3/4"	Gasket for G3/4" threaded joint	
13	1	8664.1301	Brückenfitting 3/4" Wasseranschluss	Water connection fitting 3/4"	
14	3	3035.0508	RC-Glied	RC-link	C6-C8